

Type 613

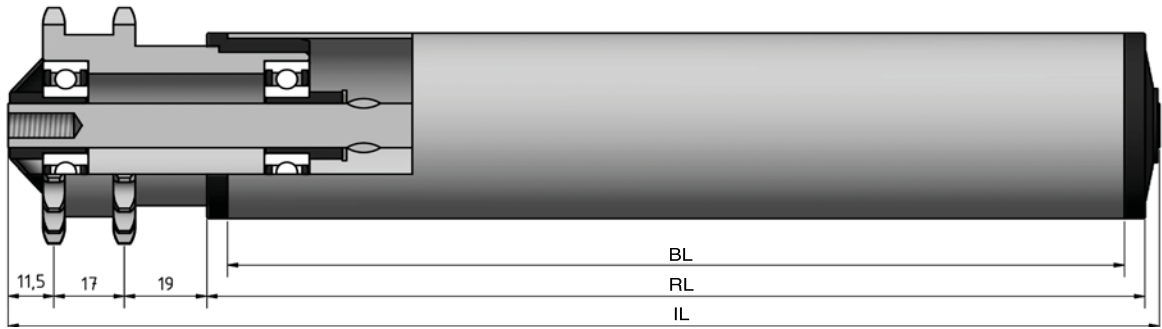

STAS

T +31 (0) 229 28 29 40
www.eschgroup.nl



HTEC

T +31 (0) 416 31 66 00
www.eschgroup.nl



CONVEYOR

T +31 (0) 416 31 56 56
www.eschgroup.nl



		IL = RL +			CODE
	BUITENDRAAD	71	73	75	UD
	VERJONGING	60	60	60	VJ
	BINNENDRAAD	60	60	60	ID
	GLAD				GA
	SLEUTELWIJDTE	60	60	60	SW
	VEREND				VA
	AS Ø	10	12	14	

		DRAAGVERMOGEN*	RL
STALEN BUIS	50x1,5	40 kg	1500 mm
	50x2	40 kg	1500 mm
	50x3	40 kg	1500 mm
	60x2	40 kg	1849 mm
	63,5x2,9	40 kg	1849 mm
	80x2	40 kg	1849 mm
RVS BUIS	50x1,5	40 kg	1500 mm
	50x2	40 kg	1500 mm
	60,3x1,65	40 kg	1849 mm
	80x2	40 kg	1849 mm
KUNSTSTOF BUIS	50x2,8	40 kg	600 mm
	63x3	40 kg	850 mm
	90x7	40 kg	1100 mm

OMSCHRIJVING

Dubbelrijige aandrijfelement 3/8"x7/32"-20*

tanden, steekcirkel=60x89 mm en groefkogellager.

Rol met **frictie aandrijving**. De frictiedruk is 5 tot 7% van het transportgoed gewicht.

*Afwijkende tanden op aanvraag

Tegenlagering: Type 100, 110, 190, 200, 250 en 300.

Keuze oppervlaktebehandelingen:

Verchromen

Epoxeren

Elektrolytisch verzinken

613





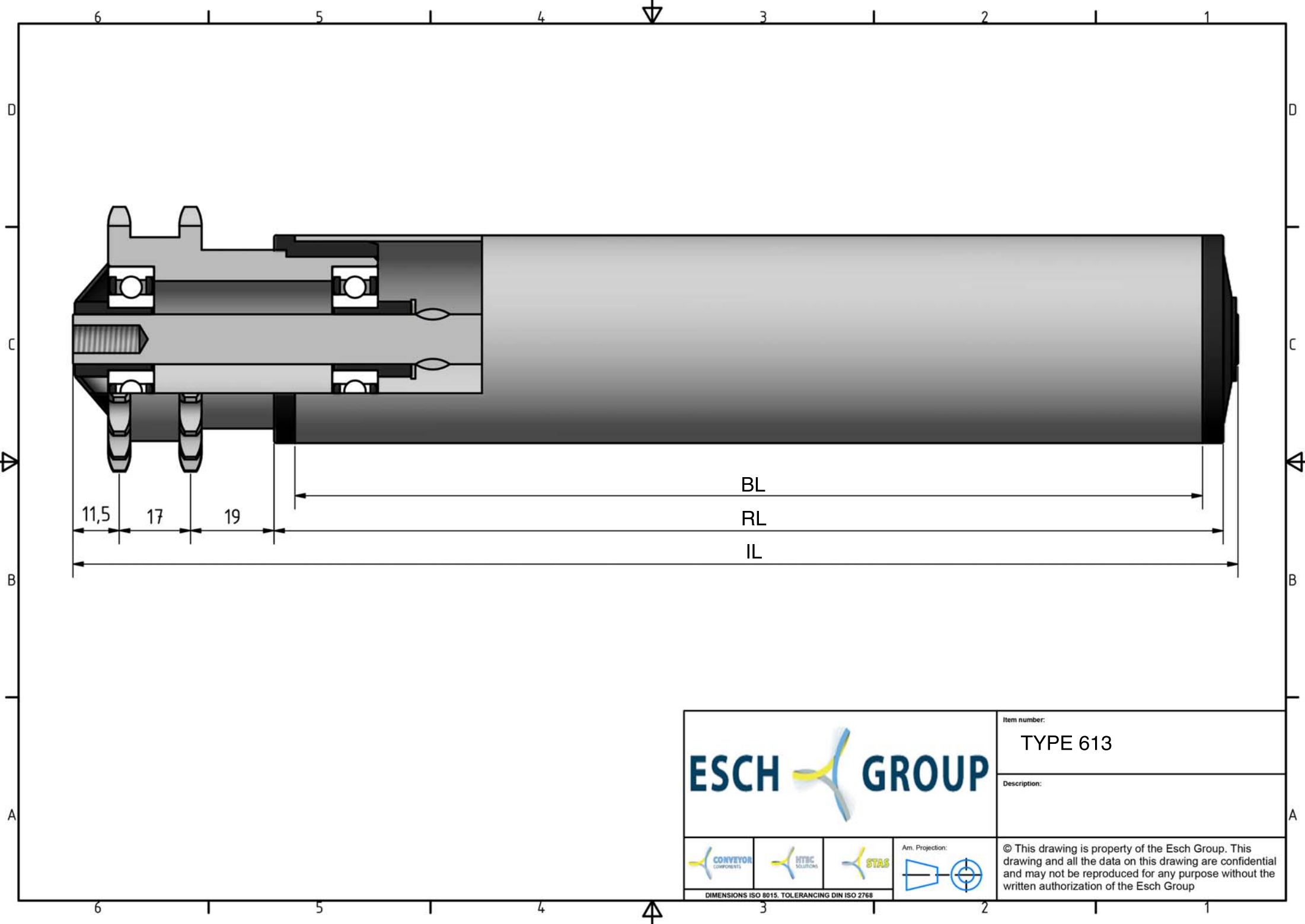

* DRAAGVERMOGEN BIJ VLAKBELASTING
GEBASEERD OP AANGEGEVEN RL.

MEMBER OF ESCH GROUP

ESCH GROUP

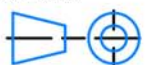

			Item number:
			TYPE 613
Description:			
			Arr. Projection: 
<small>DIMENSIONS ISO 8015. TOLERANCING DIN ISO 2768</small>			© This drawing is property of the Esch Group. This drawing and all the data on this drawing are confidential and may not be reproduced for any purpose without the written authorization of the Esch Group