

Type 651

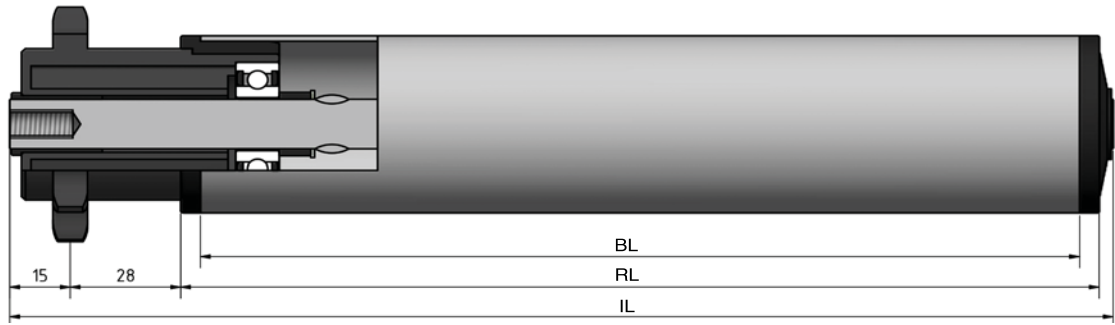

STAS

T +31 (0) 229 28 29 40
www.eschgroup.nl



HTEC

T +31 (0) 416 31 66 00
www.eschgroup.nl



CONVEYOR

T +31 (0) 416 31 56 56
www.eschgroup.nl



		IL = RL +			CODE
	BUITENDRAAD	65	67	69	UD
	VERJONGING	54	54	54	VJ
	BINNENDRAAD	54	54	54	ID
	GLAD				GA
	SLEUTELWIJDTE	54	54	54	SW
	VEREND				VA
	AS Ø	10	12	14	

		DRAAGVERMOGEN*	RL
STALEN BUIS	50x1,5	40 kg	1500 mm
	50x2	40 kg	1500 mm
	50x3	40 kg	1500 mm
	60x2	40 kg	1849 mm
	63,5x2,9	40 kg	1849 mm
RVS BUIS	50x1,5	40 kg	1500 mm
	50x2	40 kg	1500 mm
	60,3x2	40 kg	1500 mm
	80x2	40 kg	1849 mm
KUNSTSTOF BUIS	50x2,8	40 kg	600 mm
	63x3	40 kg	850 mm
	90x7	40 kg	1100 mm

OMSCHRIJVING

Enkelrijige triebstock aandrijfelement 5/8"x3/8"-12 tanden, steekcirkel=61,34 mm en groefkogellager. Vaste aandrijving door **perspassing**. Dit type is alleen inzetbaar bij **continu aandrijving** en geen start stop situaties.

Tegenlagering: Type 190, 200, 201, 202, 250, 300 en 312.





Keuze oppervlaktebehandelingen:
Verchromen
Epoxeren
Elektrolytisch verzinken

651

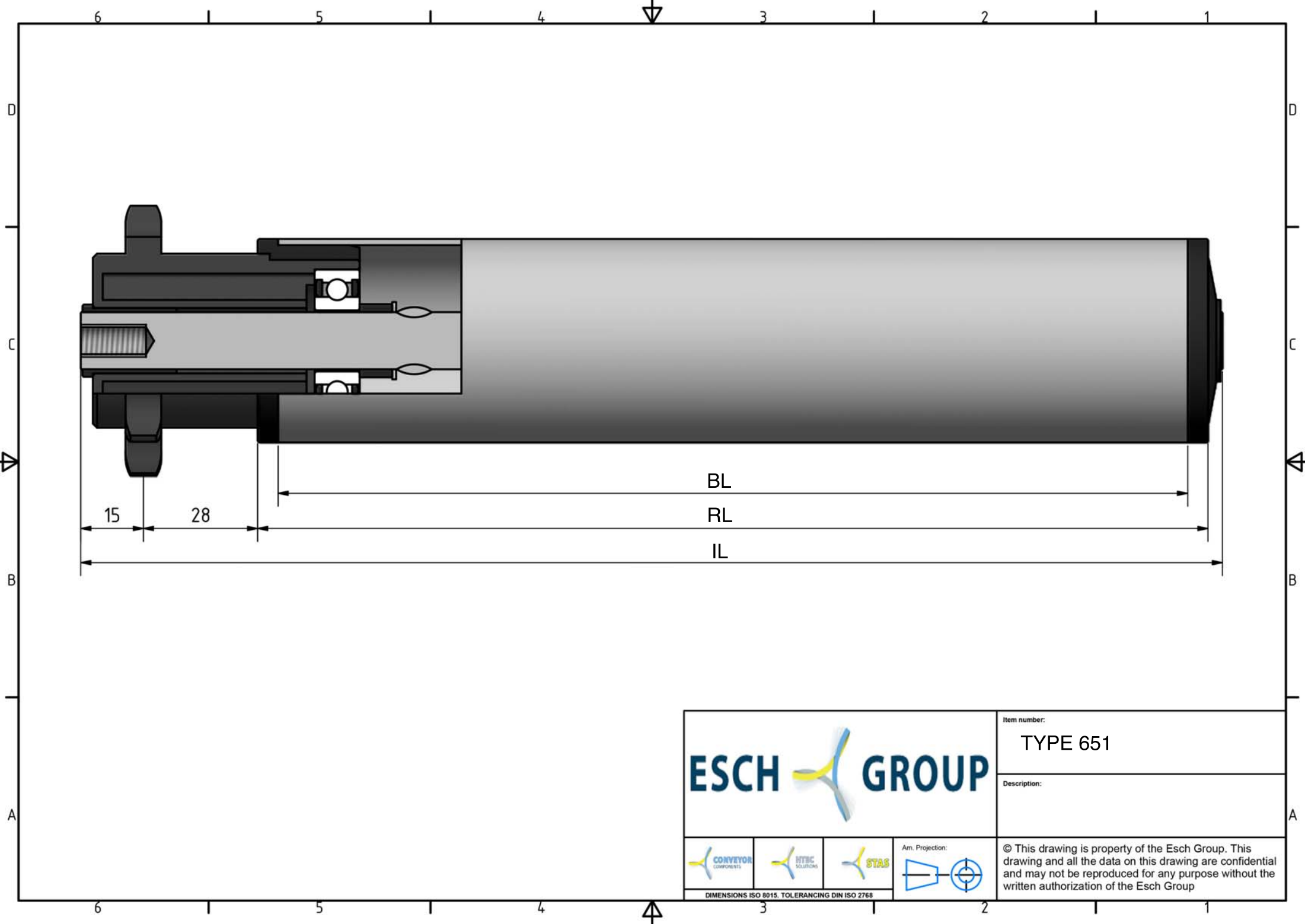

* DRAAGVERMOGEN BIJ VLAKBELASTING
GEBASEERD OP AANGEGEVEN RL.

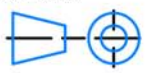

			Item number:	TYPE 651
			Description:	
			Ann. Projection: 	© This drawing is property of the Esch Group. This drawing and all the data on this drawing are confidential and may not be reproduced for any purpose without the written authorization of the Esch Group
DIMENSIONS ISO 8015. TOLERANCING DIN ISO 2768				