

Type 661

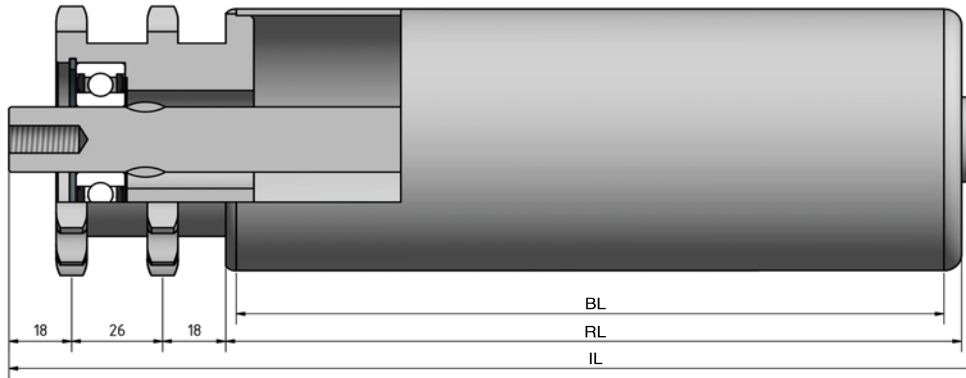

STAS

T +31 (0) 229 28 29 40
www.eschgroup.nl



HTEC

T +31 (0) 416 31 66 00
www.eschgroup.nl



CONVEYOR

T +31 (0) 416 31 56 56
www.eschgroup.nl



		IL = RL +		CODE
	BUITENDRAAD	96	101	UD
	VERJONGING	75	75	VJ
	BINNENDRAAD	75	75	ID
	GLAD			GA
	SLEUTELWIJDTE	75	75	SW
	VEREND			VA
	AS Ø	20	25	

		DRAAGVERMOGEN*	RL
STALEN BUIS	63,5x2,9	200 kg	2199 mm
	80x2	200 kg	2199 mm
	80x3	200 kg	2199 mm
	88,9x2,9	340 kg	2199 mm
	108x3,25	400 kg	2500 mm
RVS BUIS	80x2	250 kg	2199 mm
	88,9x2,9	340 kg	2199 mm
	108x3,25	400 kg	2500 mm
KUNSTSTOF BUIS	133x3,6	400 kg	2500 mm

OMSCHRIJVING

Dubbelrijige aandrijfelement 5/8"x3/8"- 15* tanden, steekcirkel=76,36 mm en groefkogellager 6004, 6204 of 6005. Gelaste aandrijving. Dit type is geschikt voor continu aandrijving en start stop situaties.

*Afwijkende tanden op aanvraag

Tegenlagering: Type 260, 306, 401, 450 en 451.

Keuze oppervlaktebehandelingen:
Verchromen
Epoxeren
Elektrolytisch verzinken

661





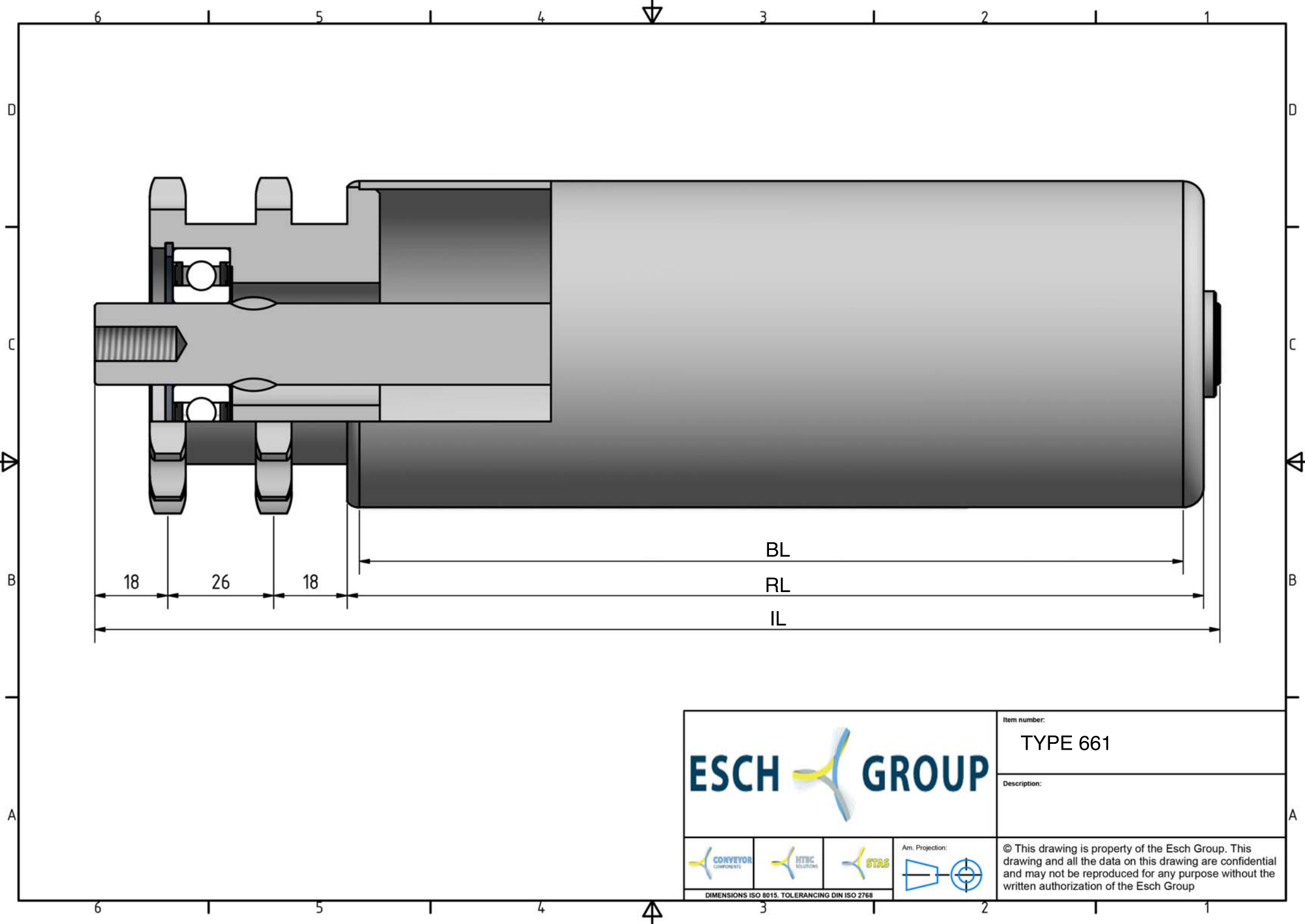

* DRAAGVERMOGEN BIJ VLAKBELASTING
GEBASEERD OP AANGEGEVEN RL.

MEMBER OF ESCH GROUP

ESCH GROUP

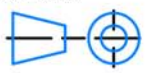

				Item number:	TYPE 661
				Description:	
				© This drawing is property of the Esch Group. This drawing and all the data on this drawing are confidential and may not be reproduced for any purpose without the written authorization of the Esch Group	
DIMENSIONS ISO 8015. TOLERANCING DIN ISO 2768					